

## **ASSEMBLY INSTRUCTIONS**

### **BX SELF-SUPPORTING CYLINDER BASES**

1. Assemble the base as shown on Drawing C750409.
2. Place the cylinder in the area the tower is to occupy. (Note: Be sure to position the base so that the tower can be hinged in the direction where there are no obstructions.) Mark off a circle approximately 2 to 3 inches larger than the cylinder.
3. Dig a hole 4 feet deep (deep enough to completely bury the cylinder below ground level).
4. Drop the cylinder in the hole and with it as vertical as possible throw the soil back into the cylinder and around it, tamping it solid after every 6 to 8 inches of fill. (Note: Be sure cylinder is flush or below the ground surface. See Drawing C750409.)
5. When the cylinder is approximately one-half full of dirt, attach the base tower section to the pipe sleeves of the base as shown on Drawing C750409. This is necessary to avoid distortion of the cylinder as you continue to fill and tamp the soil in the base.
6. Continue to fill and tamp the soil into the cylinder within 6 inches of the top.
7. Plumb the tower section by placing a level on the outside of each leg adjusting to the plumb position by loosening and realigning the BXCBI angle support brackets until the tower is plumb. (Note: The brackets must be extremely tight when the tower section is plumb.)
8. Remove the top 9/16" x 3-1/2" bolts on the pivot side of the tower that holds the pipe sleeves to the yokes. Then remove both bolts on the side opposite the pivot direction. The section can now be hinged to the ground.
9. Assemble the rest of the tower as per BX tower instructions. Hinge the tower up and when vertical put the 9/16" x 3-1/2" bolts back through the yokes and pipe sleeves. Then tighten all base bolts securely.
10. Complete filling the cylinder with dirt and tamp firmly.
11. After installation is completed, the base should be rechecked in about 30 days to be sure that the hardware remains tight and it should be rechecked every six months.

**CAUTION...** Be sure hinge bolts on hinged type accessories are loosened before attempting to hinge tower up or down. All hinged type bases are recommended to be used to raise tower only without antenna. When raising and lowering tower on any hinge type base, the loads applied for hinging the tower must be applied equally on both sides of the tower in order to reduce the possibility of twist on the tower and hinges at the base. Special care must be taken to avoid the use of raising and lowering methods which may cause damage to tower or hinges. Hinged bases should only be installed and dismantled by professional and experienced personnel.

#### **Notes:**

Do not install towers near power lines. All towers should be installed out of falling distance of power lines since every electrical and telephone wire should be considered dangerous.

ROHN recommends anti-climb sections on all towers to prevent unauthorized persons from climbing towers. Only one person should be on the tower at a time.

All antenna installations must be grounded per local or national codes.

All towers should be installed and dismantled by experienced and trained personnel.

All types of antenna installations should be thoroughly inspected by qualified personnel at least twice a year and remarked with hazard and warning labels to ensure safety and proper performance. A safety package (part number ACWS) is available which includes one anti-climb warning sign and two Danger - Watch for Wires labels along with other printed safety information.

NOTE: SEE DWG. NO. C-750429 FOR DETAILS OF TYPICAL TOP PLATE AND RIGID PLATE FOR SECTIONS 2 AND 3.

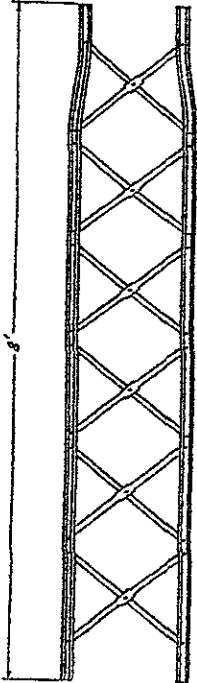
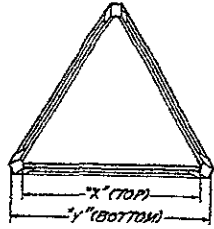
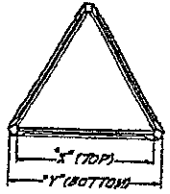
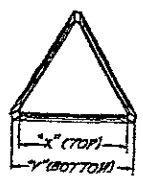

SECTIONS 2,3,4

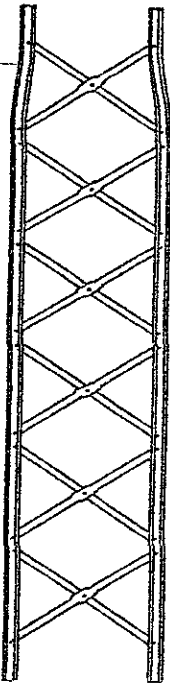

SECTIONS 5,6

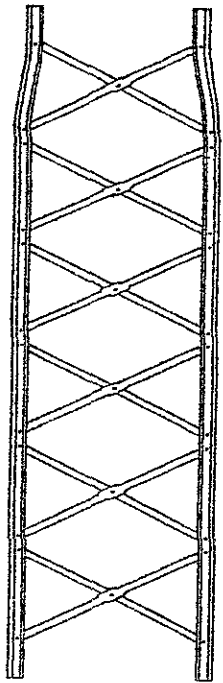

SECTIONS 7,8

ELEVATIONS OF TYPICAL SECTIONS

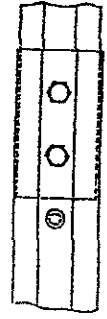

TYPICAL LEG JOINT BETWEEN SECTIONS 1-2 SECTIONS 2-3



TYPICAL LEG JOINT BETWEEN SECTIONS 3-4 SECTIONS 4-5 SECTIONS 5-6 SECTIONS 6-7

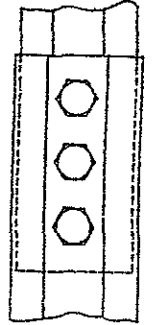

TYPICAL LEG JOINT BETWEEN SECTIONS 7-8

SECTION No.	LEG JOINT BOLTS			"X" (TOP)	"Y" (BOTTOM)
	LOCATION	QTY.	SIZE		
BX-2	TOP	2	3/8 x 3	10 7/8	12 1/2
	BOTTOM	2	3/8 x 3		
BX-3	TOP	2	3/8 x 3	12 13/16	15 1/2
	BOTTOM	2	3/8 x 1		
BX-4	TOP	2	3/8 x 1	15 3/8	17 7/8
	BOTTOM	2	3/8 x 1		
BX-5	TOP	2	3/8 x 1	17 5/8	20 1/2
	BOTTOM	2	3/8 x 1		
BX-6	TOP	2	3/8 x 1	20 5/8	22 13/16
	BOTTOM	2	3/8 x 1		
BX-7	TOP	2	3/8 x 1	23	25 1/2
	BOTTOM	3	3/8 x 1		
BX-8	TOP	3	3/8 x 1	25 1/8	28 7/8
	BOTTOM	3	3/8 x 1		

NOTE: FOR STRAIGHT SECTIONS ELIMINATE "X" DIMENSION.

NO.	DESCRIPTION	DATE	BY
REVISIONS			
<b>ROHN</b> MANUFACTURING			
DIVISION OF			
TITLE <b>BX SERIES TOWER</b> (SECTIONS 2 THROUGH 8)			
THIS DRAWING IS THE PROPERTY OF ROHN. IT IS NOT TO BE REPRODUCED, COPIED, OR TRACED IN WHOLE OR IN PART WITHOUT OUR WRITTEN CONSENT.			FILE NO.
SCALE	ADVICE	REVISIONS	FORMS
DWG. BY <b>AED</b>	DATE <b>6-6-75</b>	DESIGNED BY/ENGINEER <b>W. J. WILSON</b>	CHECKED BY/INSPECTOR <b>W. J. WILSON</b>
CHKD BY <b>DJL</b>	DATE <b>8-9-75</b>	WELDED BY <b>W. J. WILSON</b>	DRG. NO. <b>C-750430</b>
APP. BY <b>CW</b>	DATE <b>8-17-76</b>	NO. OF SHEETS <b>2</b>	SHEET NO. <b>2</b>
DRG. NO. <b>D-4</b>	DATE <b>3-11-76</b>	NO. OF SHEETS <b>2</b>	SHEET NO. <b>2</b>

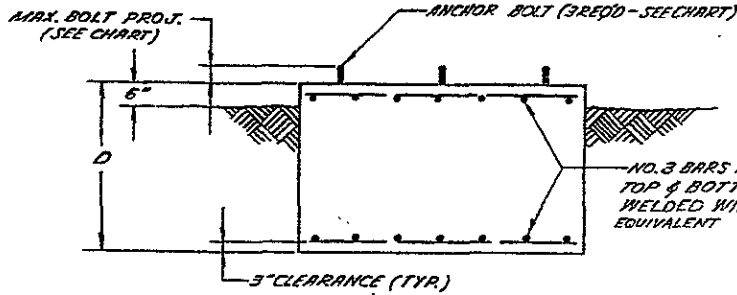
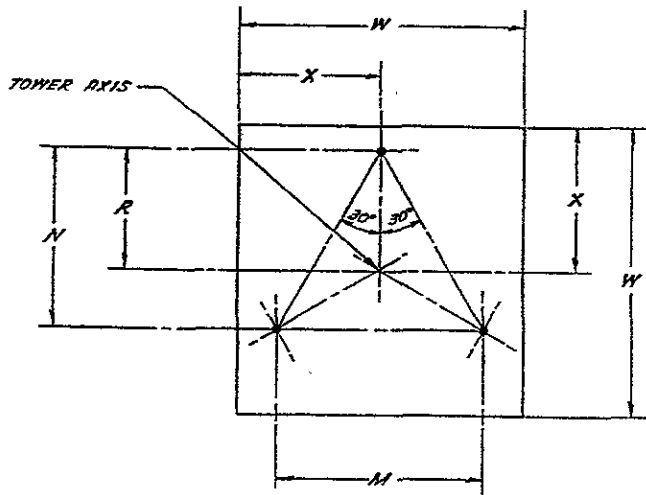

### FOUNDATION NOTES

1. CONCRETE, 3000 P.S.I. MIN. ULT. STRENGTH
2. ASTM A-615 GRADE 40 DEFORMED RE-BARS
3. ALL FORMS MUST BE REMOVED FROM CONCRETE BEFORE PLACING COMPACTED BACKFILL.
4. FOUNDATIONS DESIGNED FOR 2000 P.S.F. SOIL.
5. IT IS RECOMMENDED THAT A WOOD TEMPLATE BE CONSTRUCTED BY THE USER FOR HOLDING ANCHOR BOLTS AT THE PROPER DIM'S WHILE CONC. IS BEING POURED.
- \* 6. REINFORCING IS RECOMMENDED FOR TEMPERATURE & SHRINKAGE CONTROL.
7. WELDING IS PROHIBITED ON REINFORCING STEEL AND EMBEDMENTS.

BILL OF MATERIAL (P/N BXHC36)			
QUAN.	PART NO.	DESCRIPTION	DRG. NO.
1	BXSA1	5/16" PIPE 1 1/2" SID	C760070
1	BXAL1	5/16" PIPE 1 1/2" SID	C760070
1	BXSAH	5/16" PIPE 1 1/2" SID	C760070
1	BXSA1	5/16" PIPE 1 1/2" SID	C760070
3	BXSA1	YUKE	C760070
3	2500186	1 X 30" ANCHOR BOLT	N/A
6	220029	1" SPLIT WASHER	N/A
12	220020	3/4" HYX HEX NUT	N/A
12	240029	3/16" HEX. NUT	N/A
3	PP13	3/8" X 3/3" BEARING PLATE	N/A
6	22C300	5/16" X 3-1/2" BOLT	N/A

BILL OF MATERIAL (P/N BXHC7E)			
QUAN.	PART NO.	DESCRIPTION	DRG. NO.
1	BXSA1	5/16" PIPE 2" SID	C760070
1	BXAL1	5/16" PIPE 2" SID	C760070
1	BXSAH	5/16" PIPE 2" SID	C760070
1	BXSA1	5/16" PIPE 2" SID	C760070
3	BXSA1	YUKE	C760070
3	2500186	1 X 30" ANCHOR BOLT	N/A
6	220029	1" SPLIT WASHER	N/A
12	220020	3/4" HYX HEX NUT	N/A
12	230020	1" HYX HEX NUT	N/A
12	240029	3/16" HEX. NUT	N/A
3	PP14	3/8" X 1/2" X 3-1/2" BEARING PL.	N/A
6	22C335	5/16" X 4" BOLT	N/A

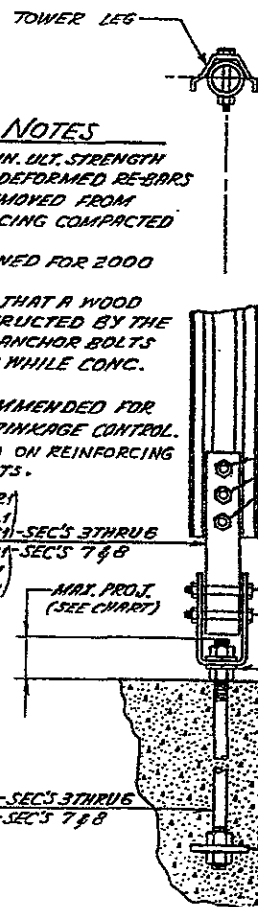

2 X 20 ANCHOR BOLT - SEC'S 3 THRU 6  
1 X 30 ANCHOR BOLT - SEC'S 7 & 8

16 X 3 BOLTS - (SECTIONS 37 & 16)  
9 X 3 L BOLTS - (SECTIONS 7 & 8)  
(A TOTAL OF 6 BOLTS IS REQ'D FOR BASE SECTIONS 3, 4, 5, 6 AND 9 BOLTS REQ'D FOR SECTIONS 7 & 8.)

2 X 3/8" BOLTS - SECTIONS 3 THRU 6  
1/2" X 4" BOLTS - SECTIONS 7 & 8  
(YUKE MK. NO. BY SRS1)

3 X 3 X 3/8" PLATE #PP13 (SEC'S 3 THRU 6)  
3/2 X 3/2 X 3/8" PLATE #PP14 (SEC'S 7 & 8)

3FT. THICK PAD FOUNDATION										
SEC. NO.	M	N	R	MAX. PROJ.	ANCHOR BOLT	BEARING PL.	D	W	X	CU YDS. CONC.
3	13 1/16"	11 1/2"	7 1/16"	2 3/8"	3-3/4" X 20"	PP13	3'-0"	3'-9"	1'-10 1/2"	1.6
4	15 1/16"	13 1/16"	9 1/16"	2 3/8"	3-3/4" X 20"	PP13	3'-0"	4'-9"	2'-1 1/2"	2.0
5	18 1/16"	15 3/8"	10 3/8"	2 3/8"	3-3/4" X 20"	PP13	3'-0"	4'-9"	2'-4 1/2"	2.5
6	21"	18 1/16"	12 3/8"	2 3/8"	3-3/4" X 20"	PP13	3'-0"	5'-3"	2'-7 1/2"	3.1
7	23 1/2"	20 1/8"	13 1/16"	3 1/8"	3-1 X 30"	PP14	3'-0"	6'-0"	3'-0"	4.0
8	26 1/8"	22 1/8"	15 1/8"	3 1/8"	3-1 X 30"	PP14	3'-0"	6'-6"	3'-3"	4.7

4FT. THICK PAD FOUNDATION										
SEC. NO.	M	N	R	MAX. PROJ.	ANCHOR BOLT	BEARING PL.	D	W	X	CU YDS. CONC.
3	13 1/16"	11 1/2"	7 1/16"	2 3/8"	3-3/4" X 20"	PP13	4'-0"	3'-6"	1'-9"	1.8
4	15 1/16"	13 1/16"	9 1/16"	2 3/8"	3-3/4" X 20"	PP13	4'-0"	4'-0"	2'-0"	2.4
5	18 1/16"	15 3/8"	10 3/8"	2 3/8"	3-3/4" X 20"	PP13	4'-0"	4'-6"	2'-3"	3.0
6	21"	18 1/16"	12 3/8"	2 3/8"	3-3/4" X 20"	PP13	4'-0"	4'-9"	2'-4 1/2"	3.4
7	23 1/2"	20 1/8"	13 1/16"	3 1/8"	3-1 X 30"	PP14	4'-0"	5'-3"	2'-7 1/2"	4.1
8	26 1/8"	22 1/8"	15 1/8"	3 1/8"	3-1 X 30"	PP14	4'-0"	5'-9"	2'-10 1/2"	4.9

UNARCO-ROHN  
Division of Unarco Industries, Inc.

The **FOUNDATION & ANCHOR BOLT DETAILS**  
for **MODEL BX TOWER**

Scale: NONE  
Drawn by: D.H. Date: 1-30-78  
Checked by: AED Date: 2-3-78  
Approved by: C.W. Date: 2-3-78

UNARCO-ROHN  
2-19-78  
C 760099 R7

F7 ADD NOTE 7  
F8 3" X 3" BOLTS TO 5/16" O.D. BOLTS  
F9 ADD BILL OF MATERIAL

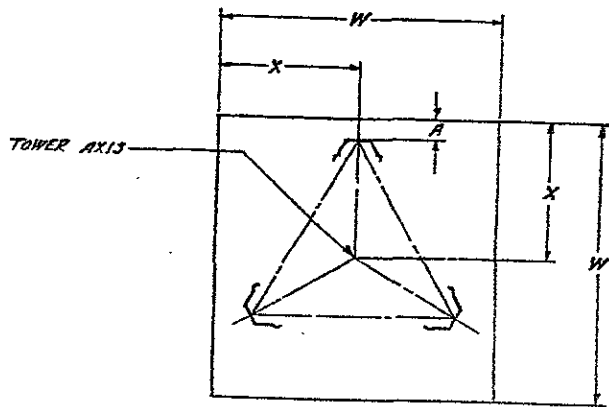

- FOUNDATION NOTES**
1. CONCRETE, 3000 PSI MIN. U.T. STRENGTH.
  2. ASTM A-615 GRADE 40 DEFORMED RE-BARS.
  3. ALL FORMS MUST BE REMOVED FROM CONCRETE BEFORE PLACING COMPACTED BACKFILL.
  - \* 4. REINFORCING IS RECOMMENDED FOR TEMPERATURE & SHRINKAGE CONTROL.

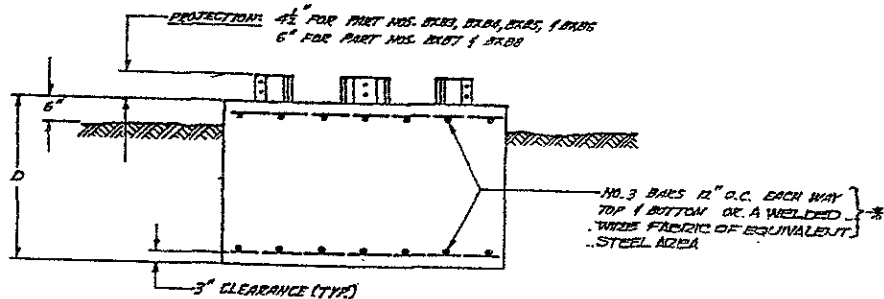

FOUNDATION PAD					
SECT. NO.	W	X	D	QU. NOS. CONC.	A
3	3'-6"	1'-9"	4'-0"	1.8	1'-0 1/2"
4	4'-0"	2'-0"	4'-0"	2.4	1'-2"
5	4'-6"	2'-3"	4'-0"	3.0	1'-3 1/2"
6	4'-9"	2'-6 1/2"	4'-0"	3.6	1'-3 3/4"
7	5'-3"	2'-7 1/2"	4'-0"	4.1	1'-4 1/2"
8	5'-9"	2'-10 1/2"	4'-0"	4.9	1'-6"

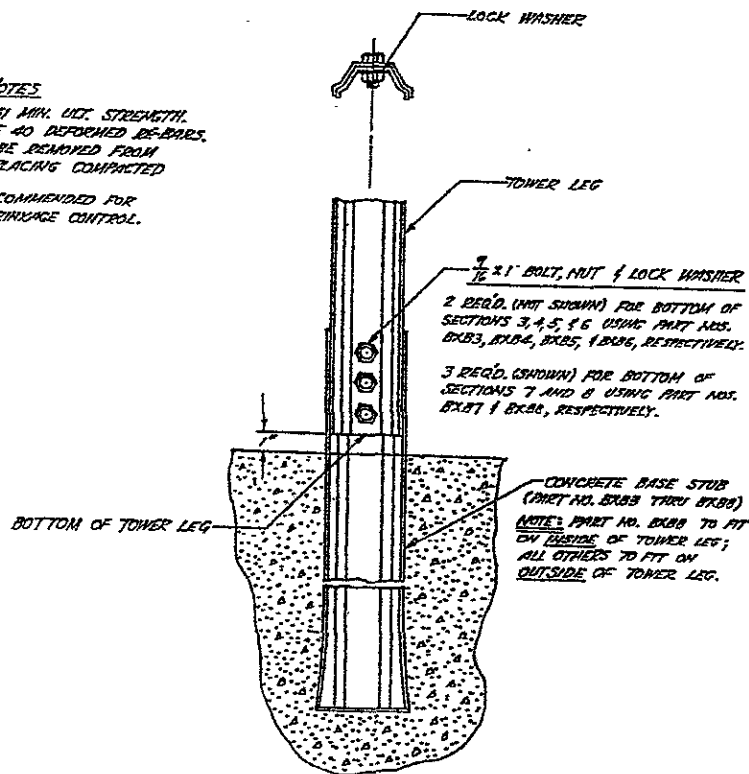

REV. DESC. LISTE		REVISION	
No.	Revision	Description	Date
<b>Unarco-Rohn</b> Division of Unarco Industrial, Inc.			
<b>FOUNDATION FOR CONCRETE BASE STUDS FOR BK TOWER</b>			
Scale: NONE			
Tolerances: Unless otherwise specified, dimensions are given in inches.			
Drawn by: <b>RED</b>	Date: <b>5-24-78</b>	Checkmarks: <input type="checkbox"/> Fraction	Angles: <input type="checkbox"/>
Checked by: <b>OKL</b>	Date: <b>5-28-78</b>	Material: <input type="checkbox"/> Flat	Weight: <input type="checkbox"/>
Approved by Engineering: <b>CW</b>	Date: <b>5-24-78</b>	The drawings are the property of Unarco-Rohn. It is not to be reproduced, copied or used in whole or in part without our written consent.	
Approved by Production:	Date:	File Number:	
Approved by Sales:	Date:	Drawing Number:	
<b>RAH 5.24.78</b>		<b>C780284R</b>	

NOTE: FOR STRAIGHT SECTION  
ELIMINATE  $\frac{1}{2}$ " DIMENSION

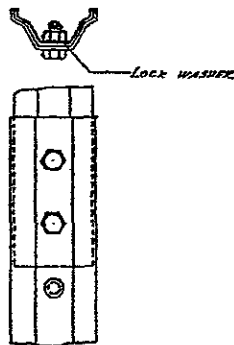
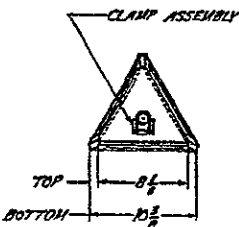

TYPICAL LEG JOINT  
BETWEEN  
SECTIONS 1-2

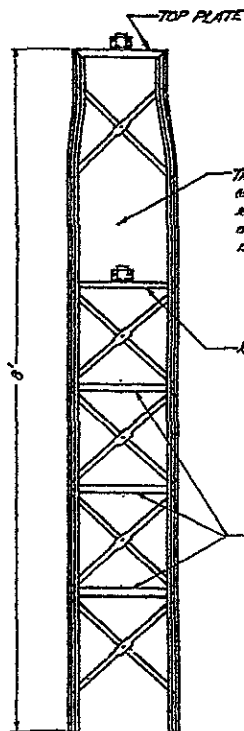

SECTION 1

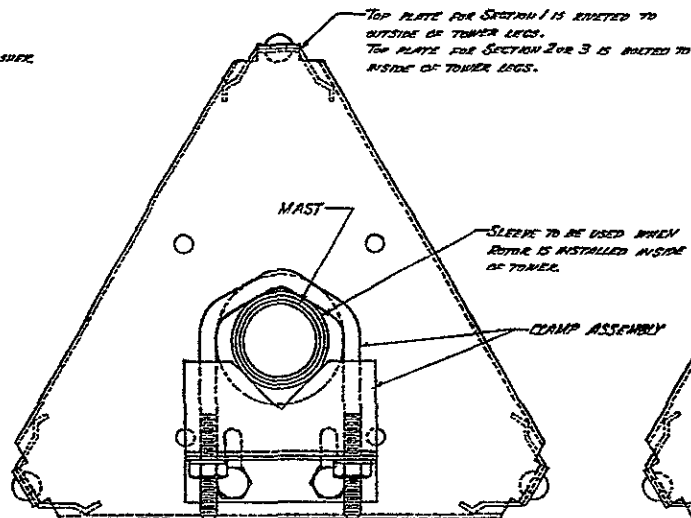

TOP PLATE WITH CLAMP ASSEMBLY

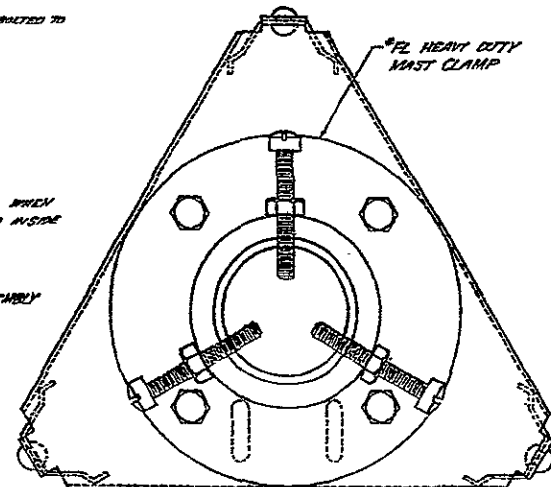

TOP PLATE WITH 1/2" HEAVY DUTY MAST CLAMP

**NOTE:**

THE CLAMP ASSEMBLY IS NORMALLY USED WITH SECTION 1 AS A TOP SECTION. THE 1/2" HEAVY DUTY MAST CLAMP IS NORMALLY USED WITH SECTION 2 OR 3 AS A TOP SECTION. HOLES ARE PLACED ON ALL TOP PLATES AND ROTOR PLATES, HOWEVER, TO ACCOMMODATE EITHER ONE.

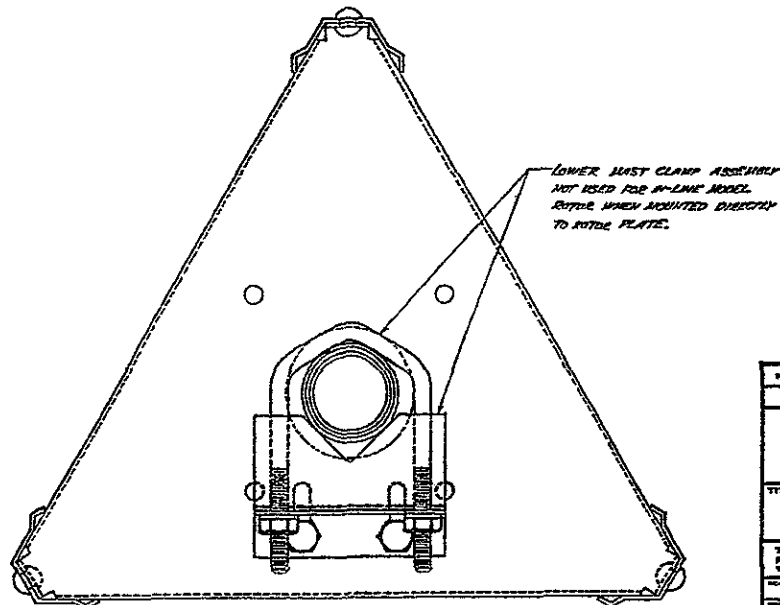

ROTOR PLATE WITH CLAMP ASSEMBLY

NO.	DESCRIPTION	DATE	BY
REVISIONS			
<b>ROHN</b> MANUFACTURING			
DIVISION OF			
TITLE <b>BX SERIES TOWER (SECTION 1)</b>			
THIS DRAWING IS THE PROPERTY OF ROHN. IT IS NOT TO BE REPRODUCED, COPIED, OR TRACED IN WHOLE OR IN PART WITHOUT OUR WRITTEN CONSENT.			
NO.	DATE	BY	CHK.
1	6-6-75	ABD	
2	2-3-76	DA	
3	3-17-76	CU	
4	7-19-76	DA	
C-750429			

**BASE ASSEMBLY NO'S**

- SECTION 3 — BX CA31
  - SECTION 4 — BX CA41
  - SECTION 5 — BX CA51
  - SECTION 6 — BX CA61
- (HARDWARE)

**BILL OF MATERIAL**

ITEM	QTY.	PKGS.	DESCRIPTION	FIG. NO.
1	3	*	CYLINDER SEC. 4 LG. (SEEDING PLAN)	C-750410
2	3		ANGLE SUPPORT BRACKET	C-750410
3	3		BX SRA1 ATTACHMENT YOKE	C-750376
4	1		BX SRA1 CENTER SLEEVE (1 1/2" PIPE)	C-750376
5	1		BX SRA1 RIGHT SIDE SLEEVE (1 1/2" PIPE)	C-750376
6	1		BX SRA1 LEFT SIDE SLEEVE (1 1/2" PIPE)	C-750376
7	1		220074 1/4" X 1/2" BOLT, RT, EP, (BLKIT)	
8	12		2100116 1/2" X 1 1/2" BOLT	
9	3		2100486 3/4" X 1 1/2" BOLT	
10	6		220080 9/16" X 3 1/2" BOLT	
11	6		280081 3/16" X 3 BOLT, EP	
12	12		240023 1/2" INTERNAL TOOTH LOCK WASHER	
13	12		250024 1/2" INT. - EXT. TOOTH LOCK WASHER	
14	12		230013 1/2" NUT	
15	3		230020 3/4" NUT	
16	12		240021 3/16" NUT, EP	
17	3		2500116 3/4" WASHER	

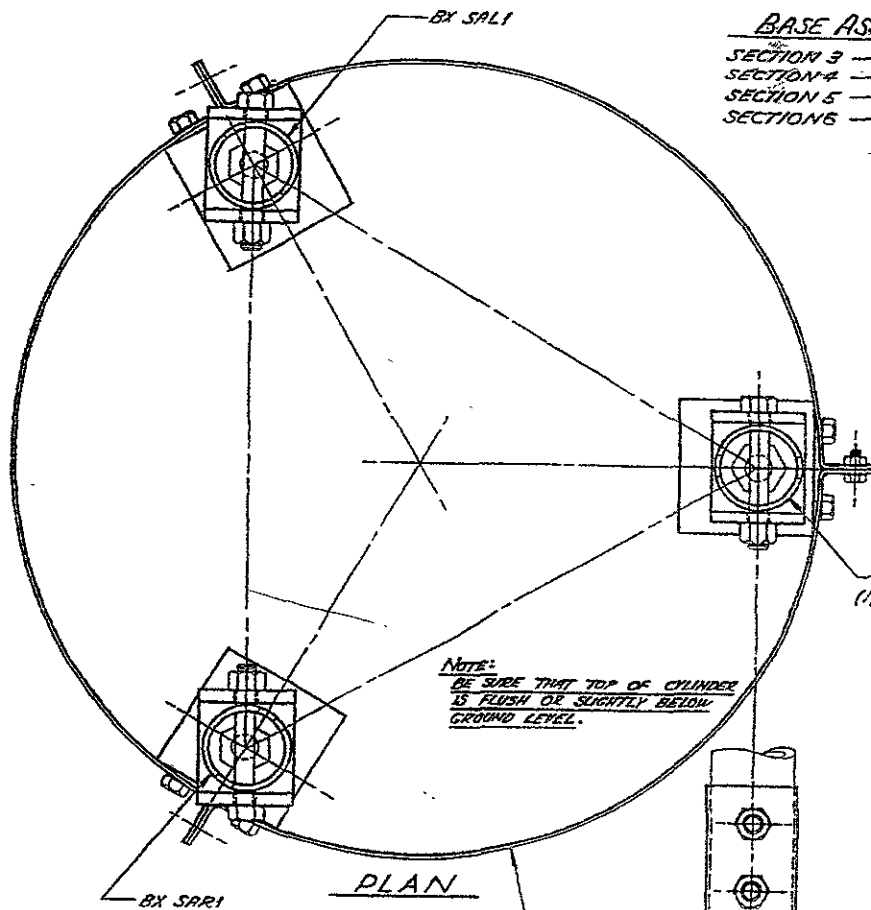

TOWER LEG (2 - 1/2" X 3 LG. BOLTS REQ'D. FOR FASTENING 1 1/2" PIPE TO BASE SECTION LEG)

1 1/2" PIPE SLEEVE TO BE BOLTED ON INSIDE OF BASE SECTION LEGS

BX SRA1 ATTACHMENT YOKE

3 - 1/2" X 1 1/2" BOLTS REQ'D SUPPORT BRACKET BX-CB1

- SECTION 3 - (BX-CB3)
  - SECTION 4 - (BX-CB4)
  - SECTION 5 - (BX-CB5)
  - SECTION 6 - (BX-CB6)
- 3 REQ'D. PER COMPLETE BASE 4'-0" LG. EACH

WASHER FOR 3/4" BOLT

3/4" X 1 1/2" BOLT

NOTE: SLOTTED HOLES ARE PROVIDED IN SUPPORT ANGLES FOR THE PURPOSE OF LEVELING THE TOWER.

1/2" X 1 1/2" BOLT

1/2" INTERNAL TOOTH LOCK WASHER

3/4" INTERNAL - EXTERNAL TOOTH LOCK WASHER

WASHER BETWEEN CYLINDER & BRACKET BX-CB1

REV.	DESCRIPTION	DATE	BY
R6	REMOVED 1/2" BOLT & NUT & ADJUST 3/16" GY	9-5-92	RRB
R5	ADDED GROUND SURFACE NOTE	3-27-79	ADD
R4	CHANGED BILL OF MATERIAL & ADDED MEMO (PARTS)	1-27-78	ADD
R3	REVISED ASSEMBLY NOS.	2-12-76	DAK
R2	ADDED ITEM NO. 11 IN PARTS LIST	2-1-76	DAK
R1	REVISED BOLT SIZES & LENGTH	1-21-76	DAK

**ROHN** MANUFACTURING

TITLE: **CYLINDER BASE INSTALLATION for MODEL BX TOWER SECTIONS 3,4,5,6**

THIS DRAWING IS THE PROPERTY OF ROHN. IT IS NOT TO BE REPRODUCED, COPIED, OR TRANSMITTED IN WHOLE OR IN PART WITHOUT OUR WRITTEN CONSENT.

SCALE	DATE	DESIGNED BY	CHECKED BY	APPROVED BY	FILE NO.
SCALE	DATE 6-4-75	DESIGNED BY	CHECKED BY	APPROVED BY	FILE NO. C-750409 R
SCALE	DATE 6-17-75	DESIGNED BY	CHECKED BY	APPROVED BY	
SCALE	DATE 7-27-76	DESIGNED BY	CHECKED BY	APPROVED BY	
SCALE	DATE 11-19-76	DESIGNED BY	CHECKED BY	APPROVED BY	



## TYPICAL TOWER ANALYSIS

TOWER DESIGN DATA: MODEL BX-64

WIND PRESSURE — 20 PSF

ANTENNA LOAD — 6 SQ. FT. AT 3 FT. ABOVE  
TOWER TOP — 1/2 IN. LINE  
ANTENNA WT. = 50 LBS.  
LINE WT. = 0.5 LBS./FT.

NOTE: ANTENNAS DEVELOPING A LARGE TWISTING MOMENT DUE TO WIND MUST NOT BE USED ON THIS TOWER. ANTENNAS SHOULD BE LIMITED TO THOSE HAVING A MAXIMUM BOOM LENGTH OF 10 FT.

SECTION No.	8	7	6	5	4	3	2	1
DISTANCE FROM TOP (FT.)	61.7	53.7	46.0	38.3	30.7	23.0	15.3	7.7
WIND ON SECTION (LBS.)	179.7	161.7	150.0	139.5	115.5	107.7	101.1	96.0
WIND ON ANTENNA & LINE (LBS.)	5.5	5.3	5.3	5.3	5.3	5.3	5.3	127.4
TOTAL WIND ON SECTION (LBS.)	185.2	167.0	155.3	144.8	120.8	113.0	106.4	223.4
SHEAR (LBS.)	1215.9	1030.7	863.7	708.4	563.6	442.8	329.8	223.4
MOMENT (FT.-LBS.)	37,770	28,790	21,530	15,500	10,620	6770	3810	1690
FACE WIDTH (FT.)	2.284	2.047	1.824	1.602	1.391	1.184	.989	.794
.866 x FACE WIDTH (FT.)	1.978	1.773	1.580	1.388	1.196	1.025	.856	.688
LEG LOAD (LBS.) <sup>①</sup>	19,100	16,240	13,630	11,170	8880	6600	4450	2460
SECTION WEIGHT (LBS.)	82	75	64	59	41	28	23	22
TOTAL WEIGHT (LBS.)	476	390	312	244	181	136	104	77
*LEG LOAD WITH WEIGHT (LBS.)	19,260	16,370	13,730	11,250	8940	6650	4490	2480
SHEAR ONE FACE (LBS.) <sup>②</sup>	815	691	579	475	378	297	221	150
cos φ	.904	.883	.858	.827	.783	.733	.667	.580
*LOAD EACH BRACE (LBS.) <sup>③</sup>	451	391	337	287	241	203	166	129

$$\textcircled{1} \text{ LEG LOAD} = \frac{\text{MOMENT}}{.866 \times \text{FACE WIDTH}}$$

$$\textcircled{2} \text{ SHEAR ONE FACE} = .67 \times \text{SHEAR}$$

$$\textcircled{3} \text{ LOAD EACH BRACE} = \frac{\text{SHEAR ONE FACE}}{2 \times \cos \phi}$$

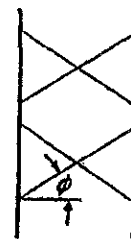

\* REFER TO DWG. No. B-760025 FOR ALLOWABLE LOADS OF MEMBERS & CONNECTIONS.

Dwg. No. A-760000