

RECEIVED
 MAR 04 2004
 Rapid City Growth
 Management Department

Wyss Associates, Inc.
 1000 14th St. SW
 Rapid City, SD 57701
 605.343.4444
 www.wyssassociates.com

Preliminary
 Plan - Not
 For
 Construction

Security First Catron
 Branch
 Rapid City, South Dakota

Lighting
 Details

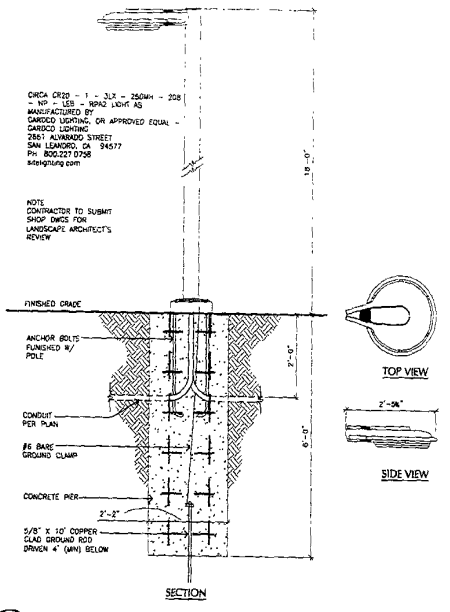

1
 L4
 DETAIL - AREA LUMINAIRES
 SCALE: 3/4" = 1'-0"

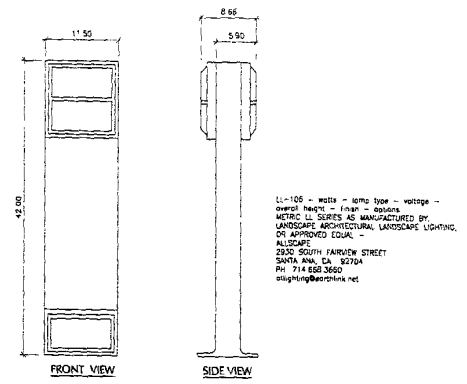

2
 L4
 DETAIL - SITE LIGHTING
 SCALE: 1 1/2" = 1'-0"

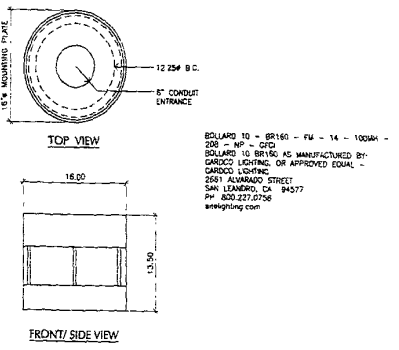

3
 L4
 DETAIL - BOLLARD (HEAD ONLY)
 SCALE: 1 1/2" = 1'-0"

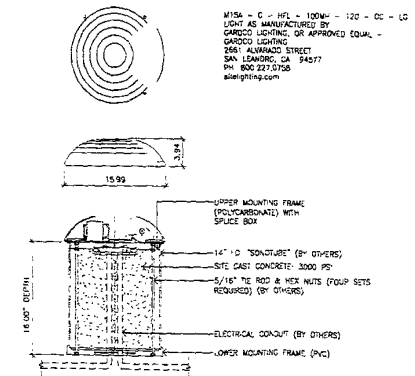

4
 L4
 DETAIL - MANTARAY WIDE FLOOD (M15)
 SCALE: 1 1/2" = 1'-0"

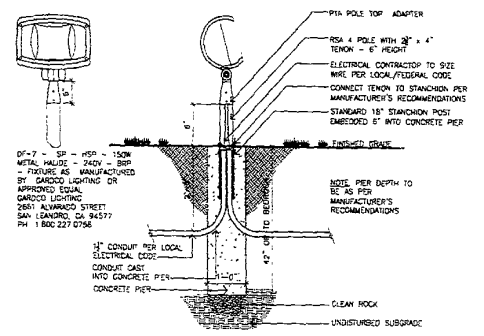

5
 L4
 SINGLE STANCHION MOUNT HORIZONTAL SPOT LIGHT
 SCALE: 3/4" = 1'-0"

04PD017

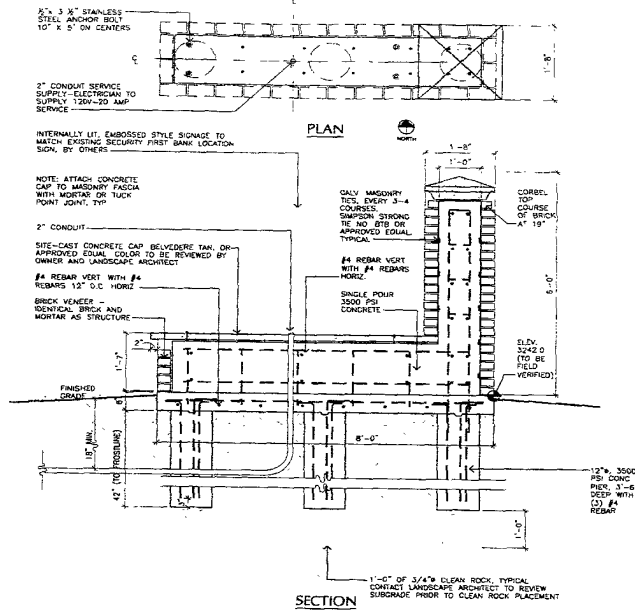

1
1.2 DETAIL: MONUMENT SIGN 'A'
SCALE: 3/4" = 1'-0"

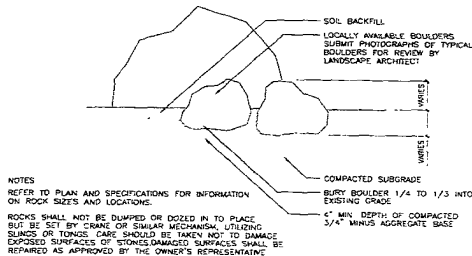

2
1.2 LANDSCAPE BOULDER PLACEMENT
SCALE: 1" = 1'-0"

FRAMES-FT-W/ (RIVEN) SQUARE LITER CONTAINER, 40 GALLON, SIDE-DOOR OPENING, KEYS LOCK, PANO LITER RECEPTACLE AS MANUFACTURED BY BRP ENTERPRISES, INC. OR APPROVED EQUAL. BRP ENTERPRISES, INC. 300701 STREET, P.O. BOX 80813, LINCOLN, NE 68501-0813, PH: 888.438.5311, WWW.BRPENTER.COM

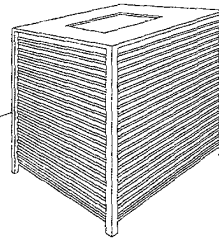

2
1.2 DETAIL - SIDE DOOR OPENING RECEPTACLE
NOT TO SCALE

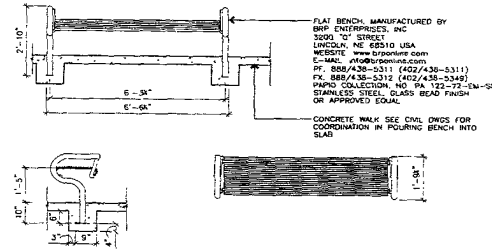

3
1.2 FLAT BENCH
SCALE: 1/2" = 1'-0"

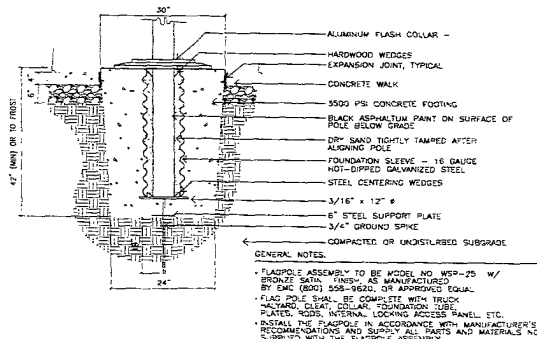

5
1.2 SECTION: FLAGPOLE FOOTING IN A CONCRETE WALK
SCALE: 3/4" = 1'-0"

Wyss Associates, Inc.
Landscape Architecture
Civil/Geotechnical
Public Administration
778 10th Street, Suite 100
Rapid City, SD 57701
Phone: 605.342.4400
Fax: 605.342.4401
www.wyssassociates.com

Preliminary Plan - Not For Construction

Security First Catron Branch
Rapid City, South Dakota

Site Details

RECEIVED
MAR 04 2004
Rapid City Growth Management Department

1.2
2 OF X