

# APPENDIX "A"

Rapid City Historic Preservation Commission



2010 Black Hills  
Home Show Booth

# Valentine McGillycuddy

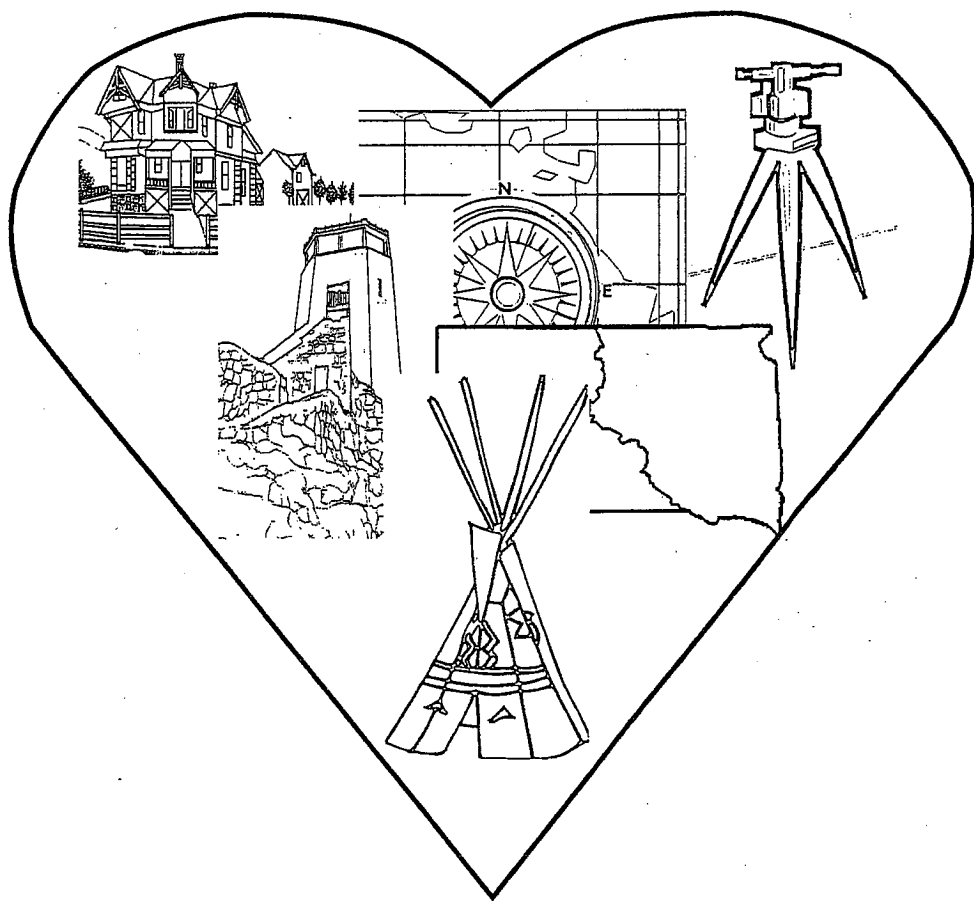

# Pioneer

Trant O'Connell McGillicuddy was born on February 14, 1849, in Racine, Wisconsin. His nickname was Valentine. He was a doctor, a topographer, mayor of Rapid City, and Dean of the South Dakota School of Mines.

He came to South Dakota in 1875 to help draw a map of the Black Hills. One of the places he visited was Harney Peak.

He worked at the Pine Ridge Indian Reservation as a doctor and built a house in Rapid City.

He died in 1939 when he was 90 years old; his ashes are buried on Harney Peak.

4

Valentine was given his nickname because he was born on February 14, 1849. What occasion do we celebrate on that day?

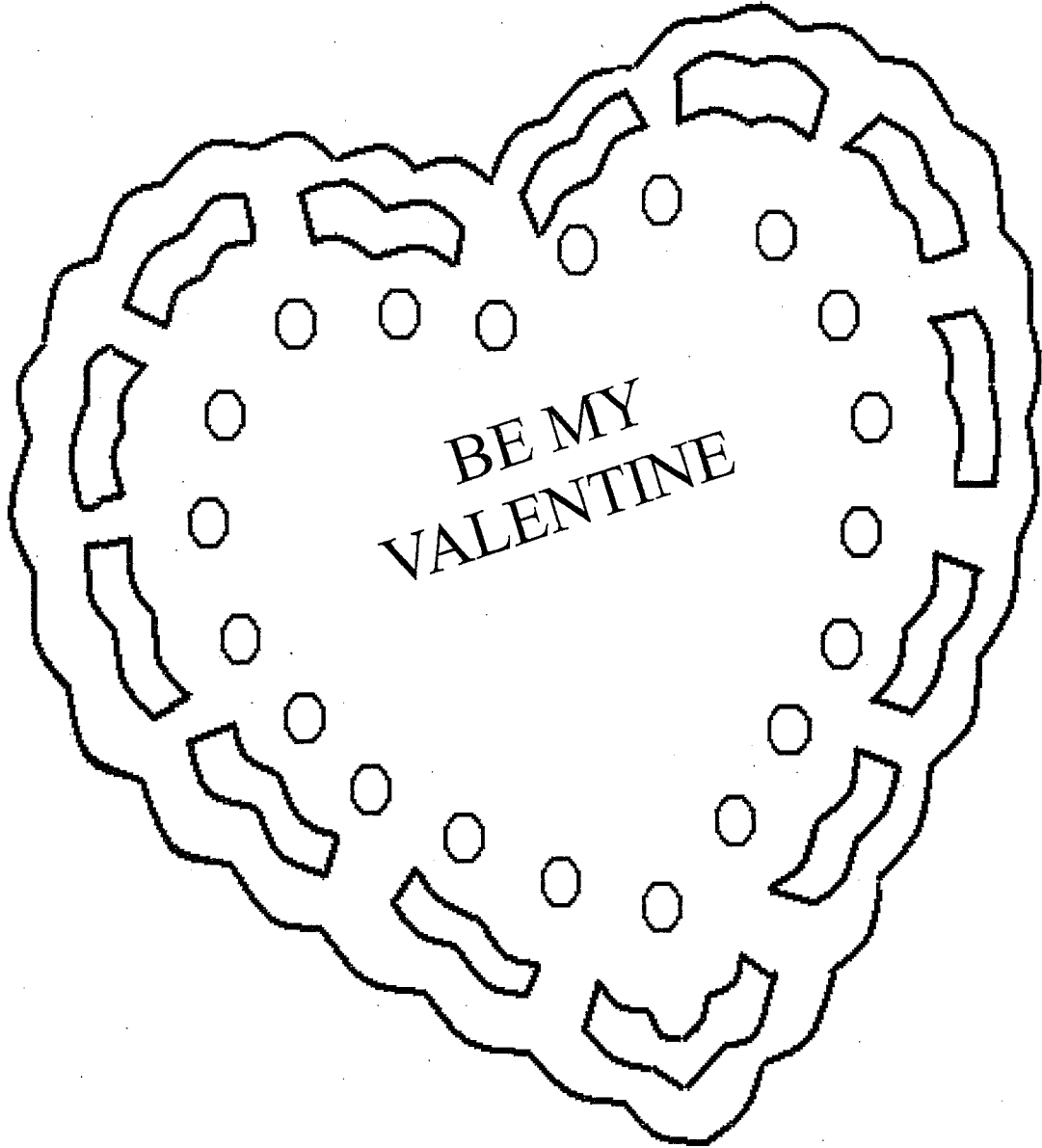

Valentine Card

6

What does the word topographer mean?

The Black Hills are located in western South Dakota. Draw a star on the map where the Black Hills are located.

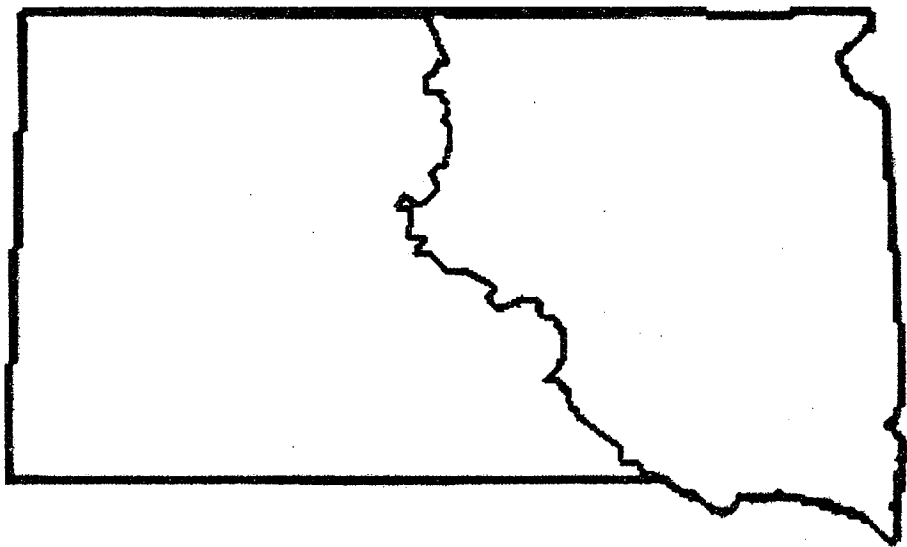

The South Dakota School of Mines & Technology is a school for people who want to learn about things like engineering and geology.

What does a geologist do?

What does an engineer do?



Harney Peak



Harney Peak is the highest mountain in South Dakota, and it is located in the Black Hills. It is 7,244 feet high. On top of the peak is a building that was once used as a fire lookout tower. A plaque at the base of the tower reads, "Valentine McGillycuddy, Wasicu Wakan."

It means Holy White Man.

Topographers used special tools to document and create their maps. This tool is called a transit. It is used to determine how high a mountain is.

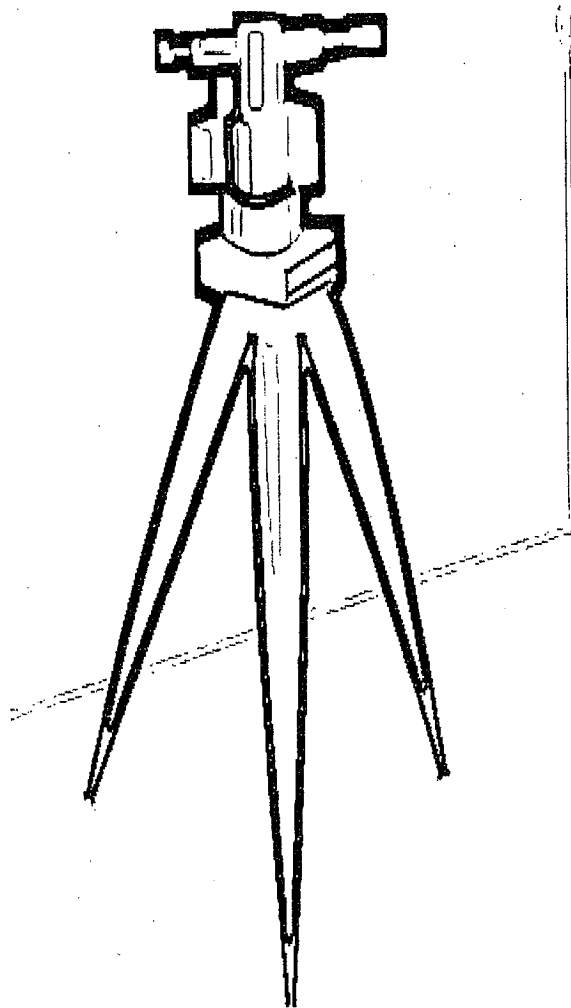

# Transit

To make a map, you have to be able to know what direction you are looking. A compass will tell you where that is. It always points north.

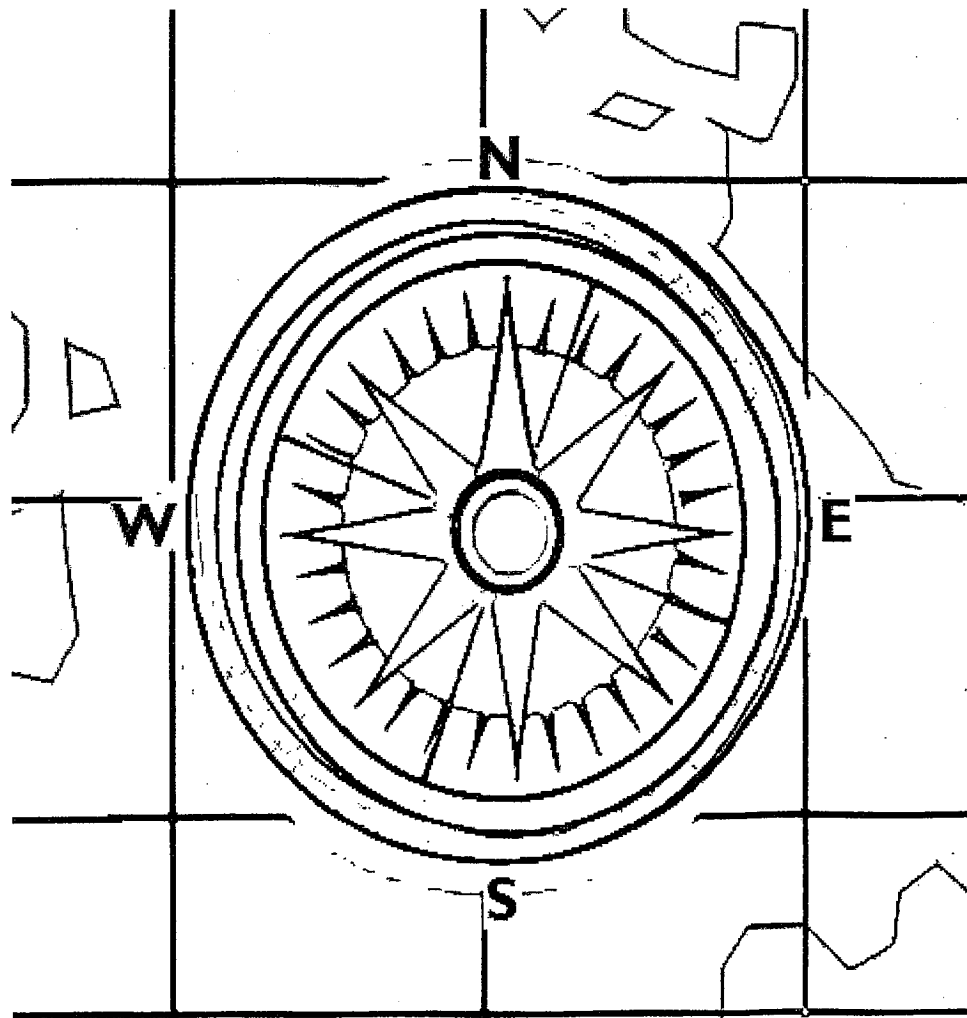

# Compass

Valentine McGillicuddy worked with the Indians on the Pine Ridge Indian Reservation. They lived in tipis. Tipis are warm and comfortable in the winter and cool in the summer. They can be taken down and packed quickly when it is time to move. Sometimes the Indians would visit Valentine at his home in Rapid City. They would bring their tipis and put them around his house.

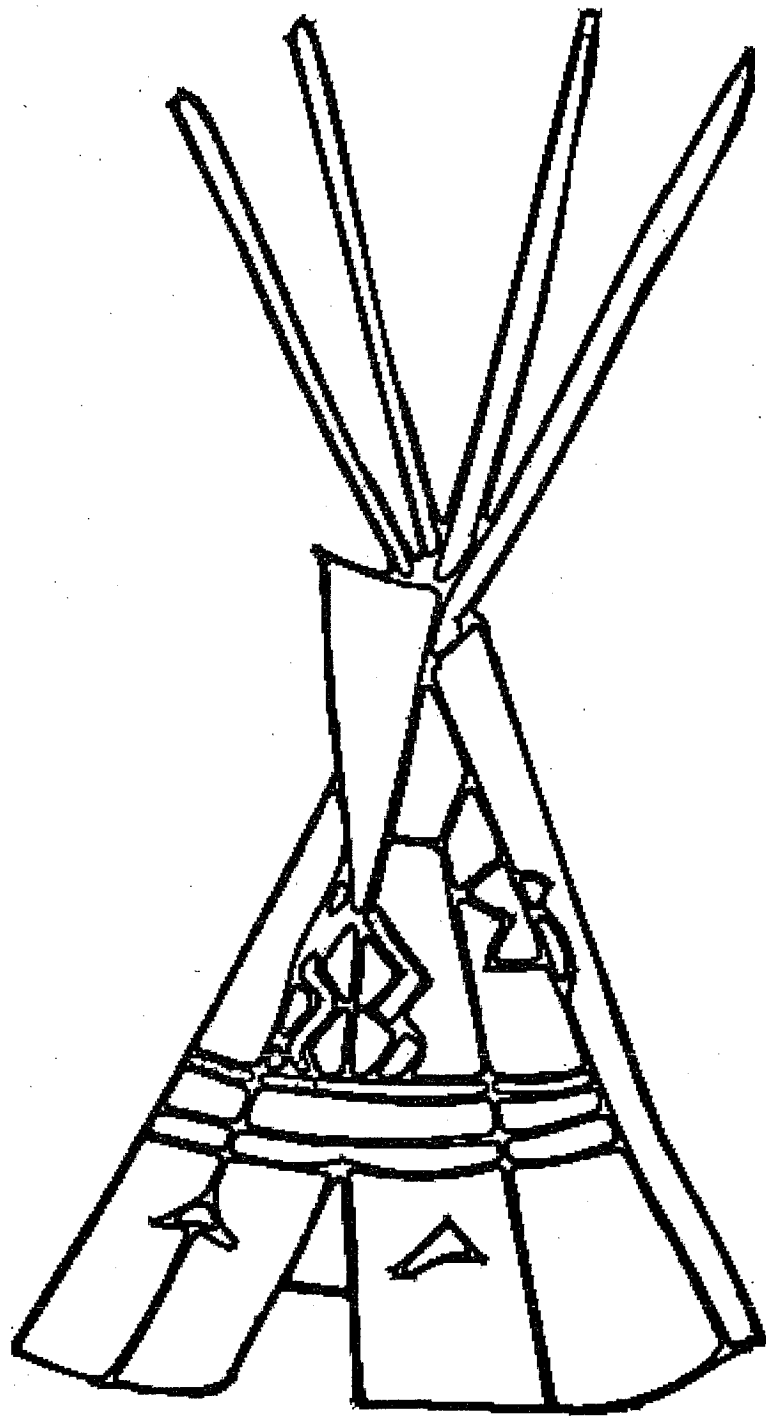

Tipi

Valentine built his house in Rapid City in 1887. It was a very colorful house with lots of decoration. The first floor of the house was made of red and white sandstone blocks that came from Hot Springs, South Dakota. The top of the house was built of wood and was painted olive green.

You can see his house today at 727 South Street.



Valentine's House

16

Valentine liked buffalos. He kept a pet buffalo in his yard.



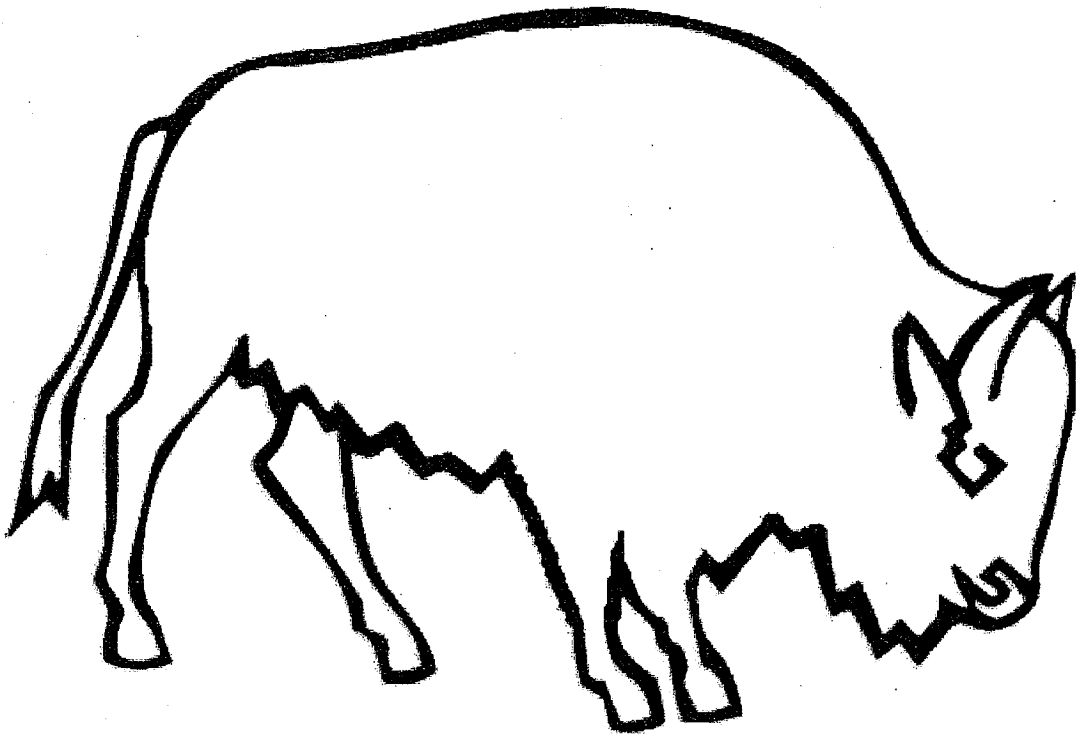

Buffalo

Created by Jean Oleson Kessloff  
and  
Betty Wagner