

LOWER MUD ROOM QTY. 1
SHIP FLAT CASING LOOSE

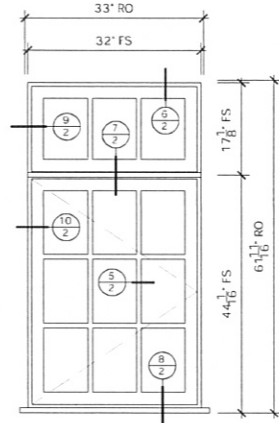

EATING QTY. 1

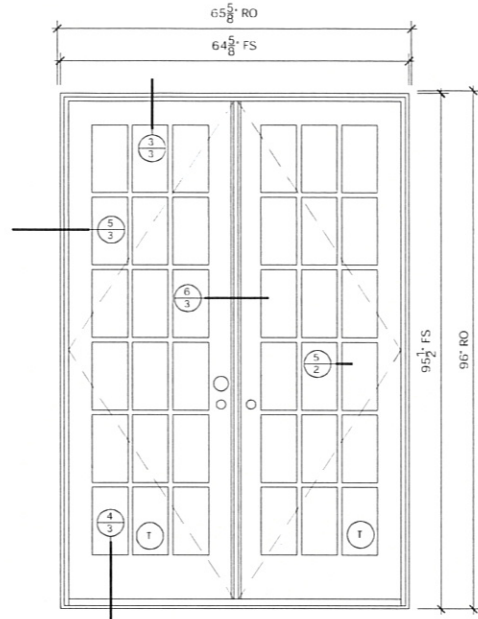

EATING QTY. 1

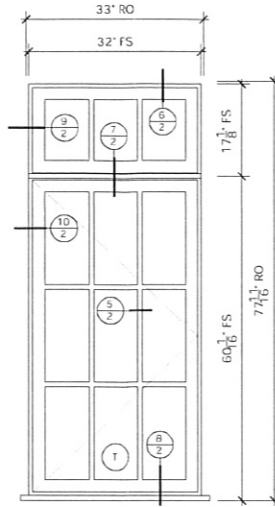

FAMILY QTY. 1

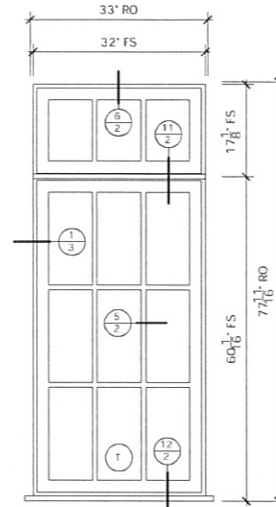

FAMILY QTY. 2

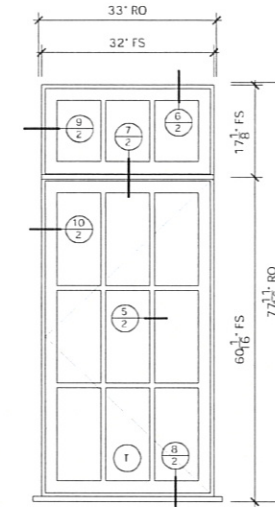

FAMILY QTY. 2

Double instead of triple transom

Custom Wood Casement Windows

- SPECIFICATIONS:
 BARE PINE EXTERIOR
 BARE PINE INTERIOR
 6 9/16" JAMB
 7/8" SDL NO SPACER BAR
 LOWE II WARGON
 CASINGS AS NOTED
 NO SCREENS
 BRONZE HARDWARE
 BLACK WEATHERSTRIP
 (T) = TEMPERED

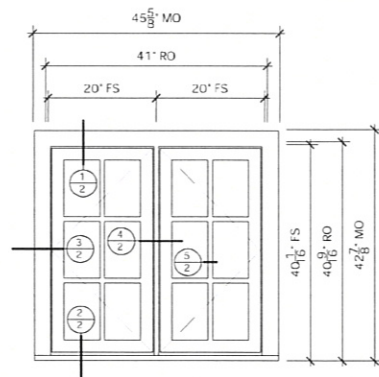

MUD ROOM QTY. 1
SHIP FLAT CASING LOOSE

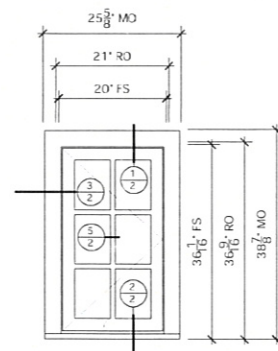

GARAGE QTY. 3
SHIP FLAT CASING LOOSE

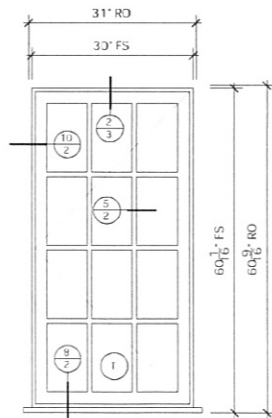

BEDROOM 1 QTY. 2

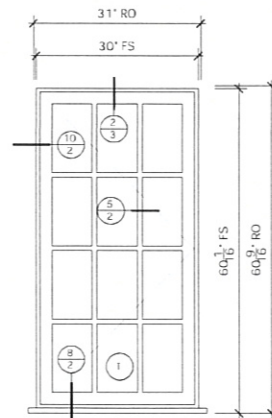

BEDROOM 1 QTY. 2

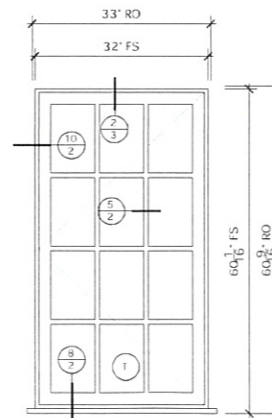

HALL QTY. 2

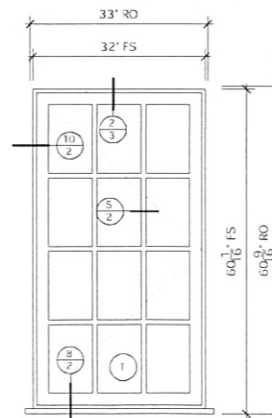

HALL QTY. 2

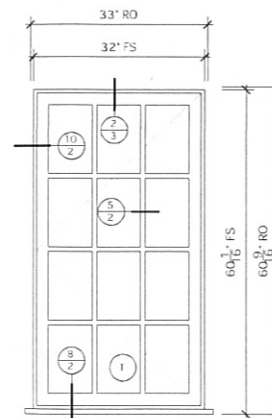

BEDROOM 2 QTY. 1

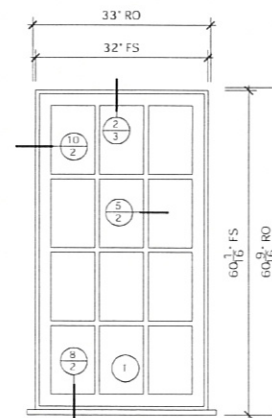

BEDROOM 2 QTY. 1

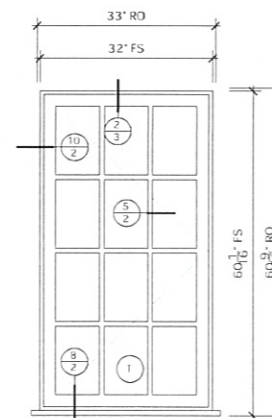

BEDROOM 2 QTY. 1



ORDERING PRODUCTS WITH REFERENCE TO SHOP DRAWINGS:
 Before ordering the Marvin Window and Door products illustrated within these drawings, the purchaser must be returned to the Architectural Division at Marvin Windows & Doors, P.O. Box 100, Wauwatosa, Minnesota 53093. If the Marvin products included herein are ordered without reference to the approved shop drawings, Marvin Windows and Doors assume no responsibility in guaranteeing product coordination with the drawings.

TUDOR ON WEST BLVD

DISTRIBUTOR: WARREN WINDOW
 DEALER:
 CONTRACTOR:
 ARCHITECT:
 DRAWING NO: 243013.dwg DRAWN BY: gregm
 DATE: 04/05/13 REVISION DATE:

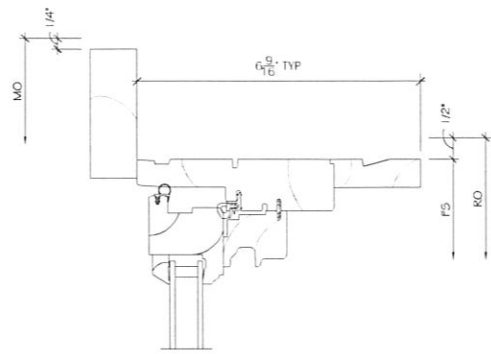

1 HEAD SCALE: 6" = 1'-0"

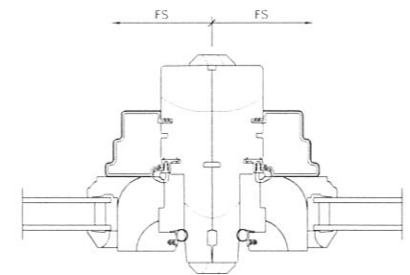

4 MULLION SCALE: 6" = 1'-0"

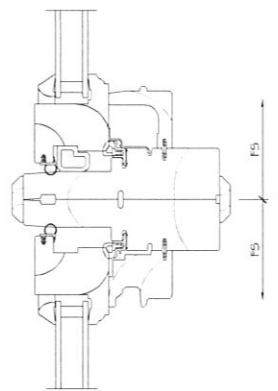

7 MULLION SCALE: 6" = 1'-0"

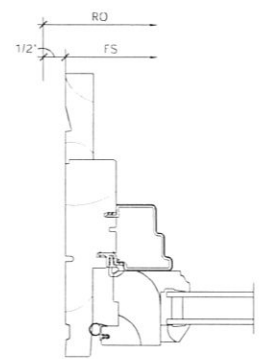

10 JAMB SCALE: 6" = 1'-0"

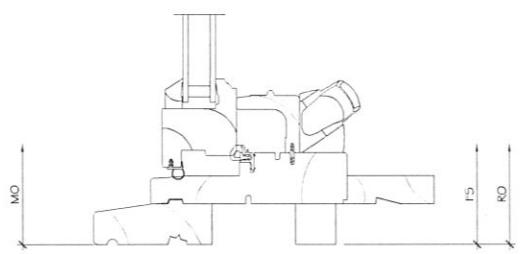

2 SILL SCALE: 6" = 1'-0"

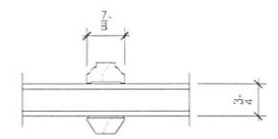

5 DIVIDER SCALE: 6" = 1'-0"

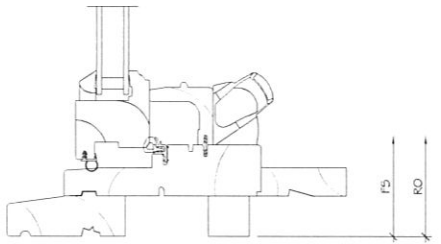

8 SILL SCALE: 6" = 1'-0"

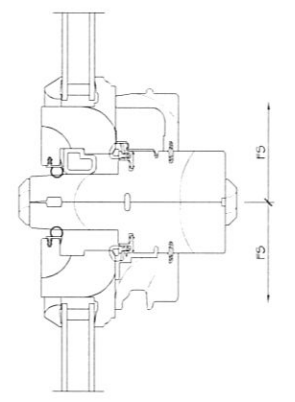

11 MULLION SCALE: 6" = 1'-0"

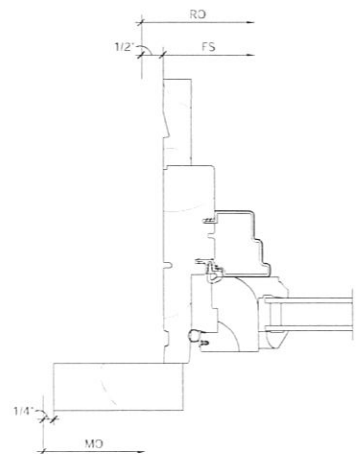

3 JAMB SCALE: 6" = 1'-0"

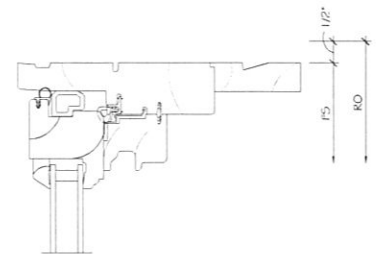

6 HEAD SCALE: 6" = 1'-0"

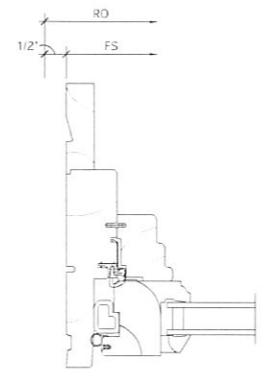

9 JAMB SCALE: 6" = 1'-0"

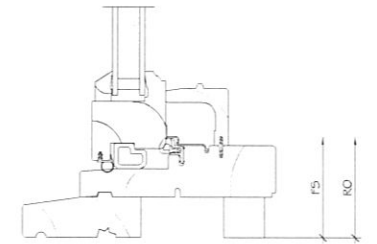

12 SILL SCALE: 6" = 1'-0"



ORDERING PRODUCTS WITH REFERENCE TO SHOP DRAWINGS: Before ordering the Marvin Window and Door products illustrated within these shop drawings, a copy of these drawings accompanied by an approved signature of the purchaser must be returned to the Architectural Division at Marvin Windows & Doors, P.O. Box 100, Warrand, Minnesota 55087. These drawings are provided as a reference to the approved shop drawings. Marvin Windows and Doors assumes no responsibility in guaranteeing product coordination with the drawings.

TUDOR ON WEST BLVD

DISTRIBUTOR: WARREN WINDOW
DEALER:
CONTRACTOR:
ARCHITECT:
DRAWING NO.: 24-3013.dwg DRAWN BY: gregm
DATE: 04/05/13 REVISION DATE:

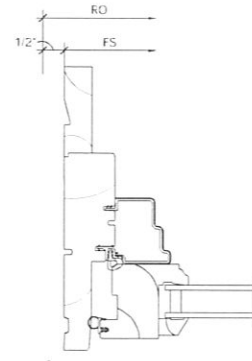

1
3 JAMB SCALE: 6" = 1'-0"

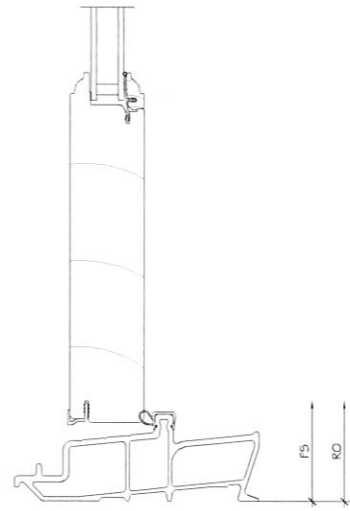

4
3 SILL SCALE: 6" = 1'-0"

7
3 NOT USED SCALE: 6" = 1'-0"

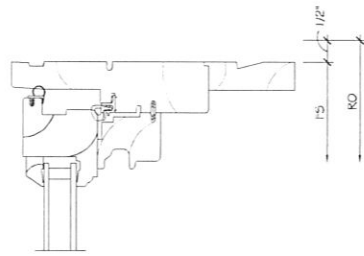

2
3 HEAD SCALE: 6" = 1'-0"

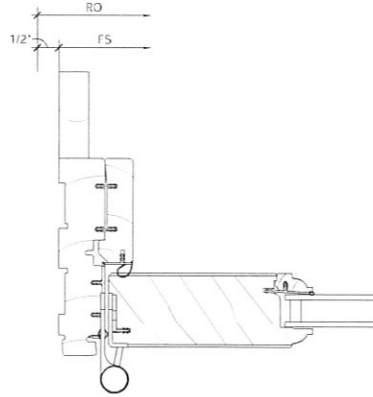

5
3 JAMB SCALE: 6" = 1'-0"

8
3 NOT USED SCALE: 6" = 1'-0"

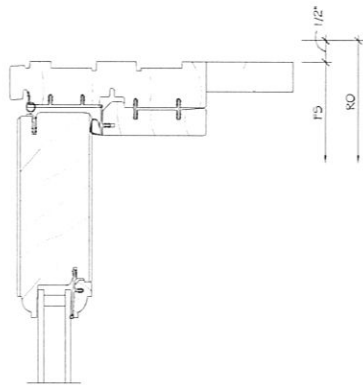

3
3 HEAD SCALE: 6" = 1'-0"

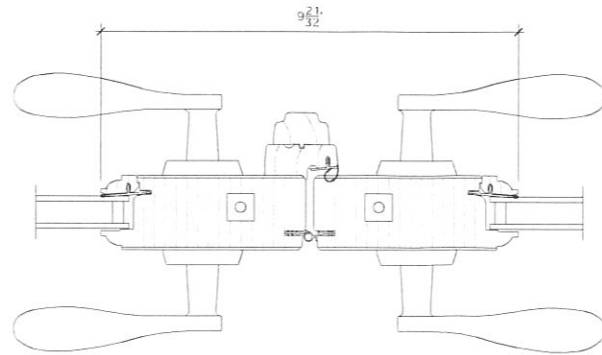

6
3 MEETING STILE SCALE: 6" = 1'-0"

9
3 NOT USED SCALE: 6" = 1'-0"



ORDERING PRODUCTS WITH REFERENCE TO SHOP DRAWINGS:
Before ordering the Marvin Window and Door products illustrated within these shop drawings, a copy of these drawings accompanied by an approved signature of the purchaser must be returned to the Architectural Division at Marvin Windows & Doors, P.O. Box 100, Warroad, Minnesota 56763. If the Marvin products included herein are ordered without reference to the approved shop drawings, Marvin Windows and Doors assumes no responsibility in guaranteeing product coordination with the drawings.

TUDOR ON WEST BLVD

DISTRIBUTOR: WARREN WINDOW
DEALER:
CONTRACTOR:
ARCHITECT:
DRAWING NO: 24.3013.dwg DRAWN BY: gregm
DATE: 04/05/13 REVISION DATE: